

Parameters	PL1.5 COB	PL1.9 COB	PL2.5 Pro	PL2.9	PL3.9	PL3.9 Pro	PL4.8	PL4.8 Pro	PL4.8 XL	PL6.9XL	Unit
Pixel Pitch	1.5625	1.95	2.5	2.97	3.9	3.9	4.8	4.8	4.8	6.94	Millimeter
Brightness	600	600	1,200	1,000	1,000	5,000	5,000	5,000	5,000	5,000	nit
Panel Dimensions	500*500*87								500*1,000*87		Millimeter
Panel Material											—
Panel Weight	9	9	9.6	9	9	9.6	9.6	9.6	12.5	12.5	Kg / Panel
Pixels	COB	COB	SMD 1515	SMD 2121	SMD 2121	Common Cathode SMD 1921	SMD 1921	Common Cathode SMD 1921	SMD 1921	SMD 1921	—
Module Size	250*250								500*250		Millimeter
Panel Resolution	320*320	256*256	200*200	168*168	128*128	128*128	104*104	104*104	104*208	72*144	pixels
Pixel Density	409,600	262,144	160,000	112,896	65,536	65,536	43,264	43,264	43,264	20,734	pixels / sqm
Refresh Rate	3,840										Hertz
Grayscale	16,384										Grade
Viewing Angle(H/V)	170/170	170/170	150/140	140/140	140/140	140/120	140/110	140/120	140/120	140/120	Degree
Ingress Protection	IP54/IP21	IP54/IP21	IP40/IP21	IP40/IP21	IP40/IP21	IP65/IP54	IP65/IP54	IP65/IP54	IP65/IP54	IP65/IP54	—
Power(max/ ave.)	510/170	510/170	510/170	450/150	510/170	750/250	540/180	750/250	600/200	600/200	Watts / sqm
Drive mode	1/20	1/32	1/20	1/28	1/16	1/8	1/13	1/7	1/13	1/4	—
Maximum Hanging	20								10		Panels



POLARIS

Assemble Your Task Force

POLARIS MODELS

— PL1.5 COB + PL1.9 COB

LED That Doesn't Break Its Promise

Absen COBALT with NanoShield technology – the first truly viable solution to the physical demands of 1mm rental display applications

— PL2.5 PRO + PL2.9 + PL3.9

Take It Black and Do It Right

The optimal way to configure high performance rental displays – perfectly balanced for extreme contrast and high pixel protection

— PL3.9 PRO + PL4.8 PRO

Beautiful On The Outside. Beautiful On The Inside

Absen High Brightness Black (HBB) technology – finally, a high resolution indoor and outdoor rental display that doesn't compromise on brightness, contrast or stability

— PL4.8

Get Closer To The Action

Flexible and efficiently sized for high resolution outdoor display applications that demand more pixels and closer viewing

— PL4.8 XL + PL6.9 XL

Lighten Up and Go Large

Super lightweight and twice the size, perfect for the operational demands of extra large outdoor display applications

INDOOR				INDOOR/ OUTDOOR		OUTDOOR			
PL1.5 COB	PL1.9 COB	PL2.5 Pro	PL2.9	PL3.9	PL3.9 Pro	PL4.8 Pro	PL4.8	PL4.8 XL	PL6.9 XL
FAST BLOCK: 0°				CURVE LOCK : -7.5 , -5 , -2.5, 0 , +2.5 , +5 , +7.5,+10					
									
500x500x87 mm		500x500x87 mm		500x500x87 mm		500x500x87 mm		500x1,000x87 mm	
600 nit		1,200 nit	1,000 nit		5,000 nit		5,000 nit		5,000 nit
9 Kg / Panel		9.6 Kg /Panel	9 Kg / Panel		9.6 Kg / Panel		9.6 Kg / Panel		12.5 Kg / Panel
A7S	A8S	A8S	A5S		A8S		A5S		A5S
TUV-CE,FCC,ETL		TUV-CE,FCC,ETL		TUV-CE,FCC,ETL		TUV-CE,FCC,ETL		TUV-CE,FCC,ETL	

NXTGEN | COBALT

Embrace The Future

Surface Flim

Surface Coating

LED Chip

PCB

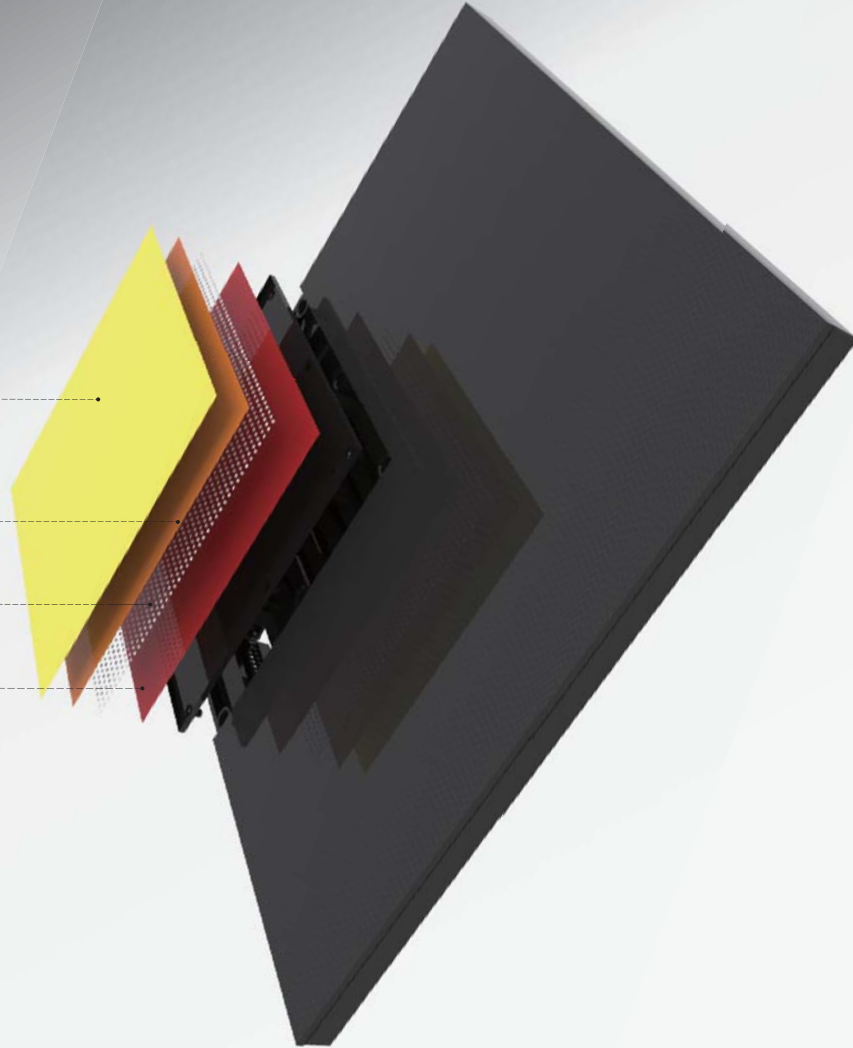

NXTGEN | HBB

Embrace The Future





1

PL1.5 COB + PL1.9 COB LED That Doesn't Break Its Promise

Absen COBALT with NanoShield technology – the first truly viable solution to the physical demands of 1mm rental display applications



Pixel Protection

Surface bonded and solid state, Absen COBALT LED diodes are encapsulated with unique NanoShield technology;

A durable anti-reflective epoxy resin coating that delivers the ultimate in physical impact protection.

Furthermore, our unique NanoShield coating provides surface electronics with enhanced IP54 rated protection from dust, moisture and water ingress.

durable anti-reflective epoxy resin coating that delivers the ultimate in physical impact protection.

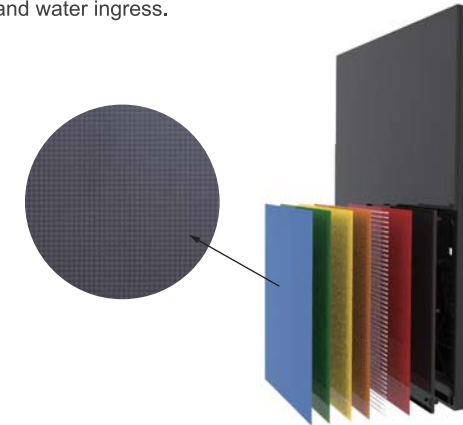

Lower Failure

Advanced COBALT production technologies completely eliminate the high temperature processes used in traditional SMD LED production that cause instability

The result. Next generation LED performance that lowers pixel failure rates by up to 50%

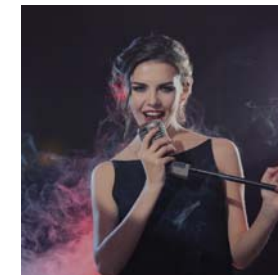

COBALT

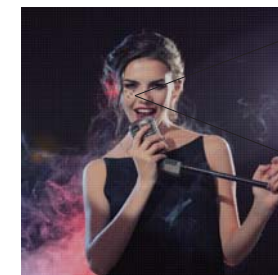

SMD





Wide Viewing Angle

Absen COBALT surface encapsulation techniques and advanced NanoShielded coating technologies deliver ultimate colour and brightness uniformity at extreme angles up to 170°

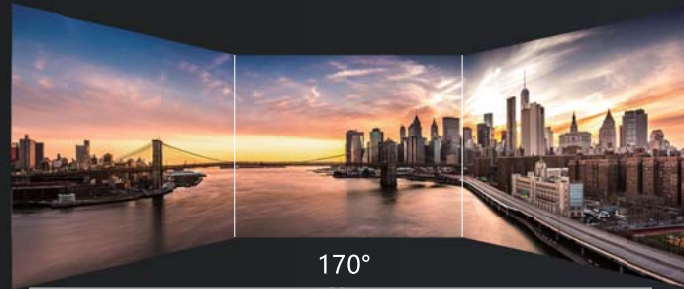

COBALT Display



SMD Display



Seam Blending

Absen COBALT and our advanced NanoShield coating technologies optimise surface light distribution resulting in optical seam-blending that virtually eliminates dark and bright lines at mechanical joints



Color Attenuation

Absen COBALT utilises high grade semi-conductor chips and our advanced NanoShield encapsulation processes prevent material contamination, maintaining higher purity levels and delivering ultimate colour performance

Furthermore, our enhanced heat dissipation design lowers attenuation, maintaining a higher brightness and colour consistency over time

Absen COBALT achieves an ultra-wide colour gamut of NTSC114% and advanced pixel-by-pixel calibration technology eliminates brightness inconsistencies for the ultimate viewing experience

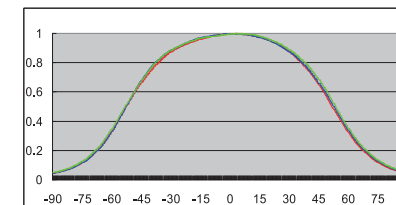
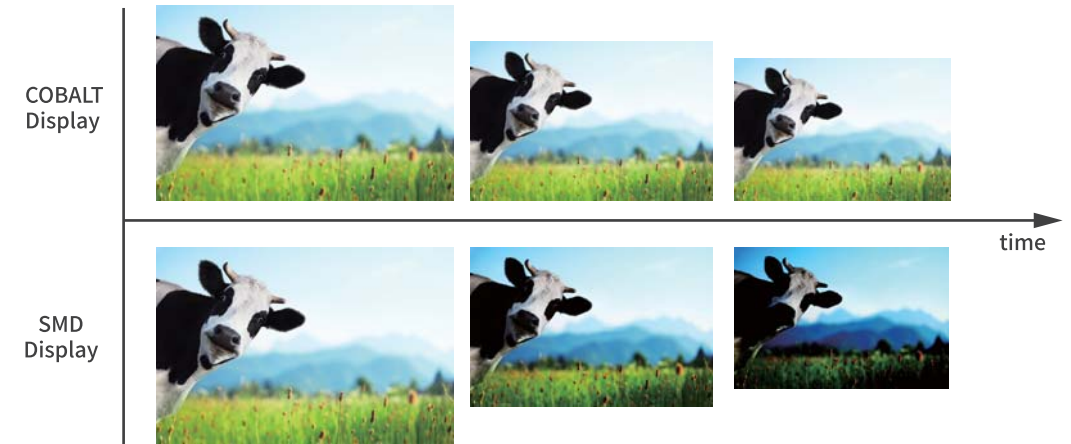

COBALT RGB Attenuation

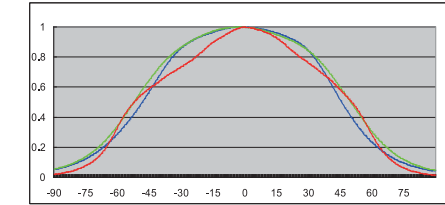

SMD RGB Attenuation

2

PL2.5 PRO + PL2.9 + PL3.9

Take It Black and Do It Right

The optimal way to configure high performance rental displays – perfectly balanced for extreme contrast and high pixel protection



UltraBlack Technology

Small sized non-reflection LEDs, combined with matte and super black mask, the PL2.5 Pro has a superior contrast compared to other LED products.

Manufactured by top tier encapsulation companies, the LEDs are providing state of the art performance in terms of uniformity, non-reflection, in both regular and wide viewing angles. The stringently controlled gluing process ensures high level of uniformity on LED surface as well as super wide viewing angle. The high quality epoxy used is the key to deliver a matte surface, which will dramatically reduce reflection even under direct light. The highest standard of aging test has proven a reliable quality and high uniformity over long time of use, with a failure rate of 30PPM only after the extreme test.

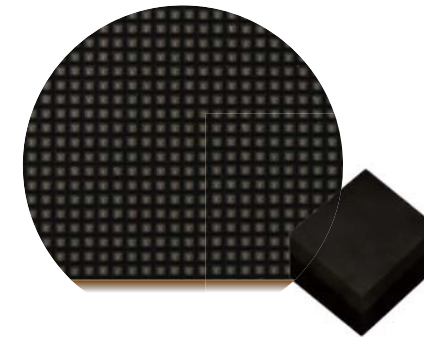

PL 2.5 Pro SMD 1515

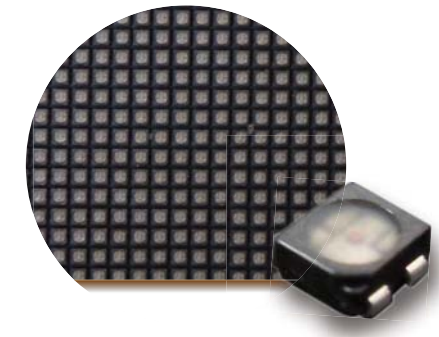

P2.6 SMD 2121

3

PL3.9 PRO + PL4.8 PRO

Beautiful On The Outside. Beautiful On The Inside
Absen High Brightness Black (HBB) technology – finally, a high resolution indoor and outdoor rental display that doesn't compromise on brightness, contrast or stability



High Contrast & Brightness

Outdoor 1921 HBB with brightness up to 5,000nit and contrast ratio of 8,000:1.

Ultra high contrast and distinct color hierarchy ensure excellent visual effect outdoors

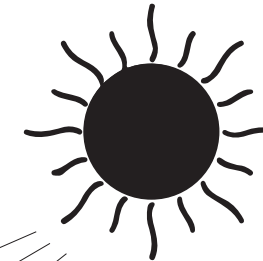

Others



1921 HBB
8,000:1 5,000nit

5,000nit HBB for outdoor use under sunlight.

LED common cathode technology improves brightness with better heat dissipation.

Color Uniformity

Precise dual power output of 2.8V and 3.8V mitigates the heat dissipation problems in LED operation with voltage drop and increases the luminous efficiency of red light.

Die-casting AL cabinet with heat plate designed for IC driver layout guarantee extraordinary heat dissipation, color consistency and uniformity.



High Resolution

HD outdoor 3.9mm HBB fits for indoor and outdoor applications.



Outdoor



Indoor

20% - Lower Heat, 20% + Higher Brightness

Standing for High Brightness Black, Absen HBB utilises Absen Common Cathode technology, a powerful solution for driving high resolution black LED at ultra high brightness

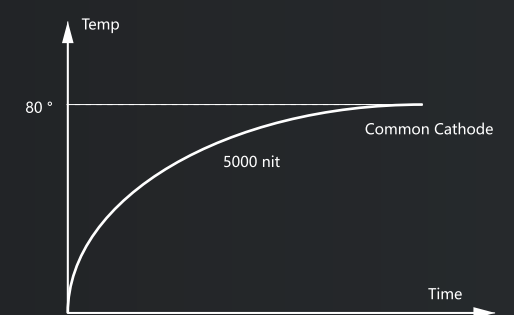
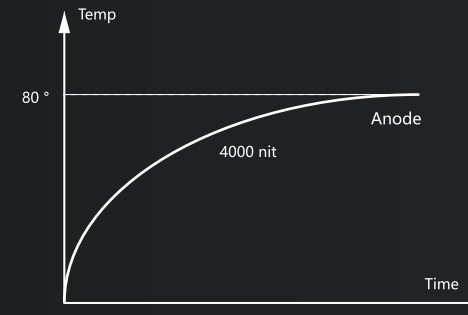
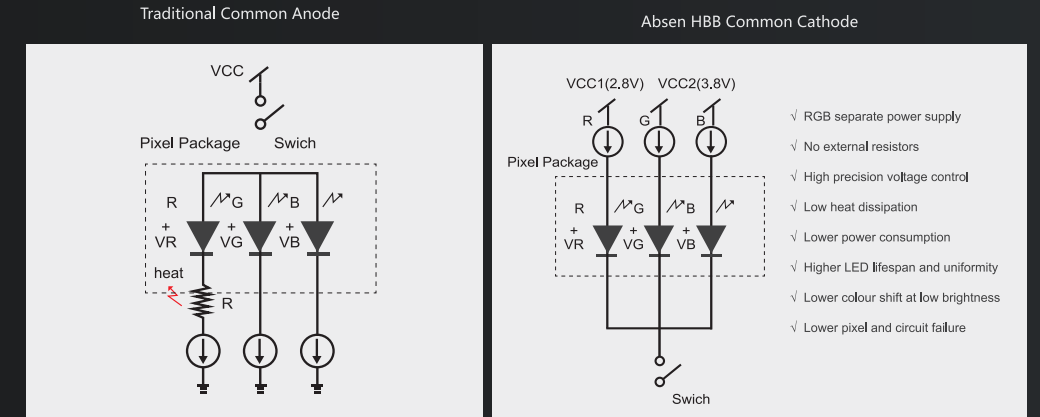

Operating Temperature: 50°C 24H White display

**BETTER
VISUAL
PERFORMANCE**



Viable indoor & outdoor solution

— Higher Utilisation



— Support More Applications

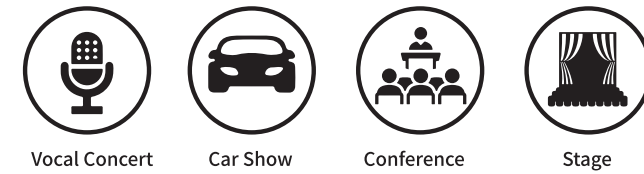

— Better ROI (return on investment)

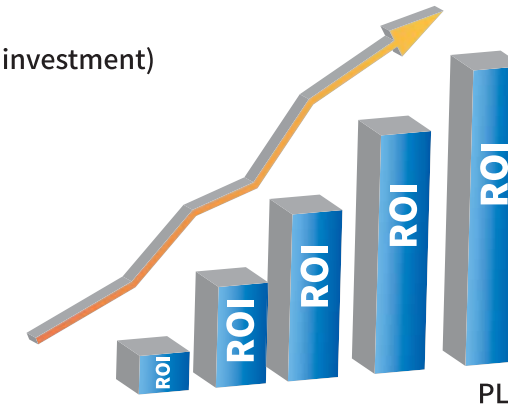



4

PL4.8

Get Closer to The Action

Flexible and efficiently sized for high resolution outdoor display applications that demand more pixels and closer viewing



Made For Mobile

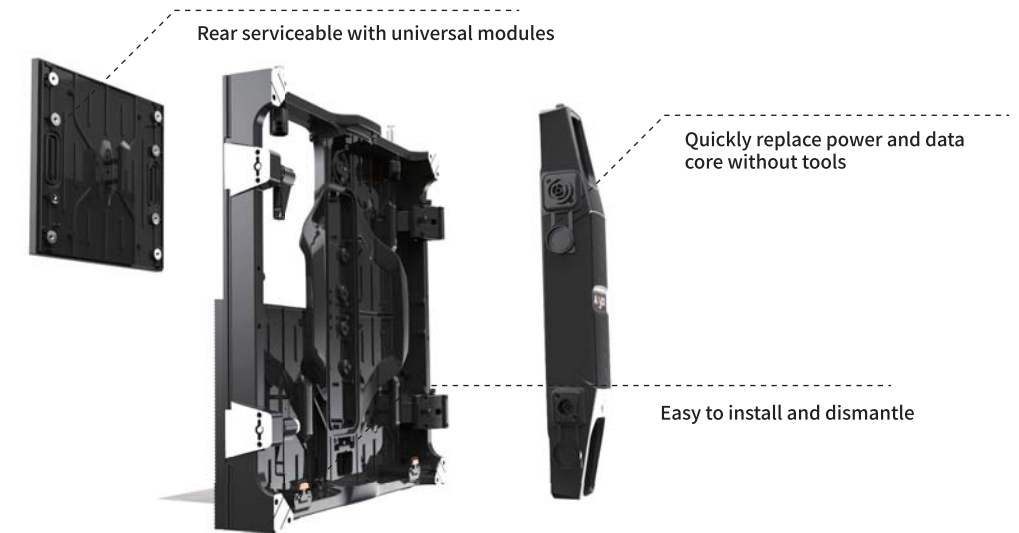

Need More Curves

In addition to the integrated curves...
Curving brackets are available:





5

PL4.8 XL + PL6.9 XL

Lighten Up and Go Large

Super lightweight and twice the size, perfect for the operational demands of extra large outdoor display applications



Lightweight



① Panel weight only

12.5Kg

② More than

20% LIGHTER

than regular products



Quick

① One man installation

② Quickly service power box

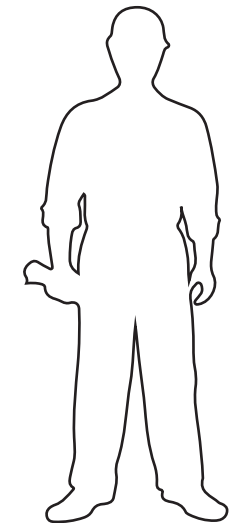

Advanced

Auto-Lock and Auto-Eject systems

- Auto-locking Vertical Lock System With Magnetic Auto-connection For Fast And Easy 1 Man Installation With Ultimate Safty And Pixel Procection
- Auto-ejection Side Lock System Enables Super Fast, Easy And Convenient Disconnection Of Panels

1 >> Panels will be attached together by magnets automatically.



2 >> Hold the bottom of the Panels upward.



3 >> Pull the knob of top lock system to lock the Panels.



Advanced (Except for PL1.5 COB and PL1.9 COB) inner and outer curve lock systems

— Innovative integrated repositionable curve connection block system maintains the highest level of alignment accuracy, in both flat or curve configuration.

Curve connection blocks are available to support any increment of curve from -7.5 convex to +10 concave giving users unlimited design flexibility and control

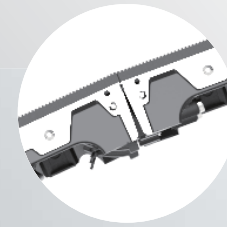

Fast rear service



Pull the Handle



Push-then-Pull Modules



Pull the Module from Rear

Additional benefits

Momento Cliente

Momento Cliente

CBX

1

Memory on Module/Hub

Calibration data stored in both module /Hub and receiving card, no need re-calibration after replacement

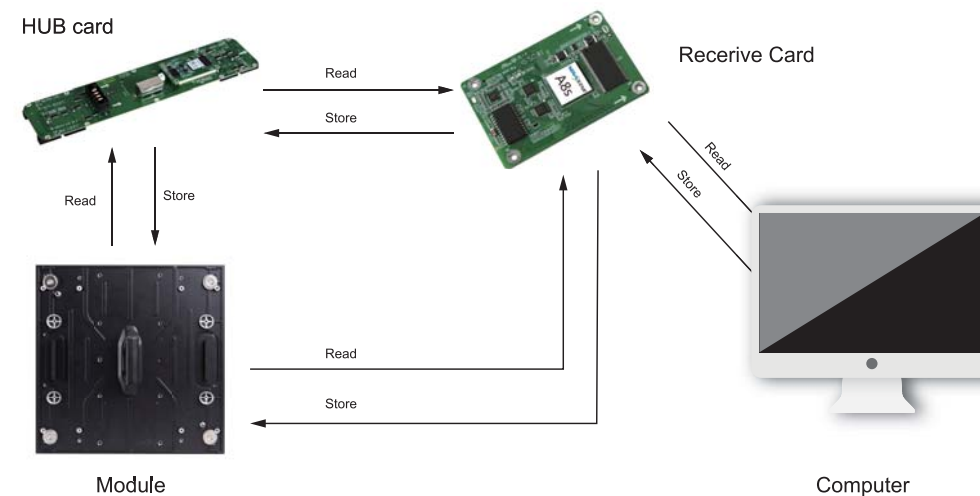

2

Processing

Premium image quality, 4K processing



3 **Advanced** calibration and uniformity

Refresh rate up to 3840Hz, delivers extraordinary image quality even at 1/3000 high-speed camera, with no flickering, perfectly meet the high demand of switching pictures smoothly at broadcasting.

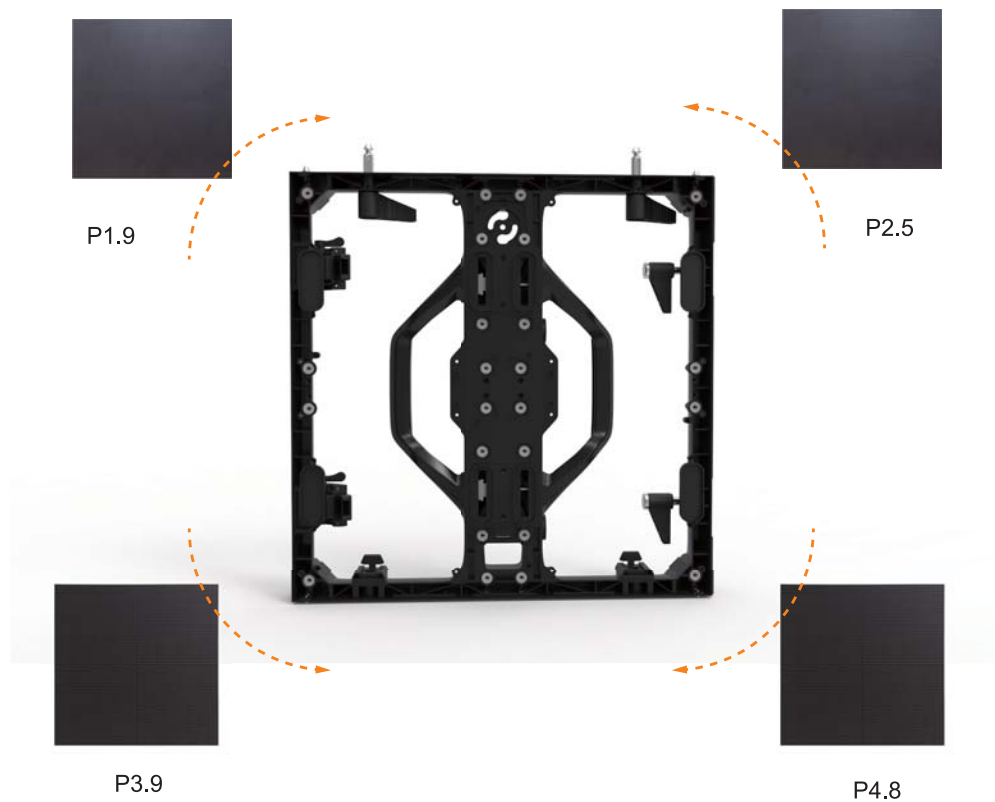

4 **Advanced** flight case with pixel-protection

5 Advanced stacking system

Drop, pop, and lock ground support for quick and easy floor installation.



8+ Overseas Subsidiaries

USA Germany UAE Russia Mexico Brazil Japan HK



Network System

Whole network system makes life easier



Platform

Build platform for more active interaction



Customized

Customized products for clients

